

**Work  
has *never*  
felt this  
good**



*100% electric*

*Road legal*

*Bed load up to 800 kg*

*Custom configurations*

---

# Score points with the people behind the desk and behind the wheel

### Pleasure is practical

Garia Utility's compact, 100% electric vehicles are designed to give operators the most pleasant working conditions in the industry. Which makes sense, since happy, satisfied employees are the most efficient, productive employees.

With Garia Utility, you get the most spacious, ergonomic cab on the market. The best driver visibility. Easy, fast entry and exit. Agile maneuvering in tight spaces. A sublimely smooth driving experience. What's more, everything that's needed to do the job right is always right within reach. Practical, right?

### Pleasure is quality

Tell the world your company stands for quality. Scandinavian craftsmanship makes Garia Utility vehicles stand out, for their looks and performance.

Every vehicle is designed and built in Denmark with the best European components and the most skilled workers. No challenge is too big. No detail too small. Day in and day out, we meet the demands of stop-and-go operations so that work just feels easier. Don't be surprised if that quality mindset rubs off on the people doing your work, too.

### Pleasure is peace of mind

You can expect reliability and durability from the vehicle itself and the team behind it. Since 2015, Garia Utility vehicles have been used across Europe – by some of the biggest logistics players, the smallest resorts, the most prestigious municipalities, the best-known companies and everything in between.

Unlike the competition, our vehicles are crash-tested and proven safe. You can also rest easy knowing that your electric vehicle is environmentally and financially responsible. And since every vehicle is configured exactly as you want, you can be certain it meets your needs today, tomorrow and every day.

# Range: up to 200 km Speed: up to 55 km/h Bed load: up to 800 kg Electric? Of course!



ROAD LEGAL



TURNING RADIUS FROM 3.9 M



CRASH-TESTED AND SAFE



MULTIPLE BATTERY OPTIONS



FITS NARROW SPACES



# Going electric feels good. Looks good. *Is good.*

You're smart to be considering an electric utility vehicle. But perhaps you need to convince others? Here are just a few of the many reasons why businesses around the world are investing in electric vehicles (EVs) instead of fossil-fuel alternatives. With a vehicle from Garia Utility, you . . .

### Help the planet

Eliminate harmful emissions and make the air cleaner and safer for everyone. You'll reduce your carbon footprint.

EVs also use energy more efficiently than combustion engines.

### Save money

You'll spend less in the long run with an EV. Save on operation and maintenance costs. EVs last longer, too. Avoid reliability issues and engine wear-and-tear from stop-and-go operations. Most European countries also offer subsidies. Plus, you'll avoid congestion taxes.

### Eliminate risk

With an EV, you futureproof your operations. Not only do you align with European Green Deal goals; you meet today's and tomorrow's regulatory standards.

### Generate goodwill

Send a valuable branding signal with your EV. You'll demonstrate corporate social responsibility and minimize dependence on foreign oil. Whether indoors or outdoors, you'll work quietly and discretely any time of day or night. And prevent illness and irritation from exhaust fumes.

### Make life easier

Get easy access virtually anywhere without blocking traffic. You'll never have to worry about oil changes, sparkplugs or gearbox service. Stop buying and/or storing fuel, too.

### Improve working conditions

You'll provide a healthier workspace and give employees more reasons to be proud. Work becomes more enjoyable and efficient.



100%  
ELECTRIC



*Whatever the temperature or weather, the 100% electric motor in your Garia Utility vehicle is designed to perform.*



# 3 models. Countless ways to make you happy.

The **Garia Utility Park** handles virtually any task in pedestrian areas, car-free zones and campus environments.

All can be used indoors or outdoors and easily navigate narrow spaces. And all release zero emissions, of course!

Use the **Garia Utility City** on busy and narrow streets any time of day or night (class L7e).

You can configure and customize any model with the features and accessories that match your exact needs. Hundreds of different configurations are possible.

Or, get wherever you want to go fast with the **Garia Utility Urban**, a class N1 vehicle. Financial incentives are even possible.

Not sure where to start (or finish)? Your Garia Utility dealer can help you determine precisely what makes the most sense for you.



## Public sector

**Typical uses:** municipalities, hospitals, universities, parks, public spaces and more

The push to go green is on! Make your mark in a way that makes a great impression on the public.

- Operate quietly at any time of day or night
- Navigate narrow gates, crowds, road blocks and bike paths with ease, and park anywhere without blocking traffic
- Get in and out of the vehicle easily and quickly
- Send a safe, secure and green signal to your surroundings

*Best choice: any model!*



## Facility management

**Typical uses:** industrial sites, hotels, resorts, events and more

Whether indoors or outdoors, your compact Garia Utility vehicle takes goods and people wherever they need to go.

- Increase convenience and productivity with an emissions-free vehicle that can work virtually anywhere
- Use an engine that thrives on stop-and-go operations and short trips
- Drive straight into the warehouse or factory building
- Send a green signal that's literally quiet but figuratively makes a lot of welcome noise

*Best choice: any model!*

## Leisure & outdoor

**Typical uses:** zoos, amusement parks, camping sites, golf courses, equestrian centers, forestry, agriculture and more

Who wants to be disturbed when they're trying to relax, concentrate or simply experiencing the great outdoors?

- Keep a low profile for sound and a high profile for sustainability
- Work easily, effectively and discreetly in confined spaces
- Add to the attractiveness of the away from-home experience
- Keep workers happy so they greet guests with a smile

*Best choice: Park or City models*



## Last-mile delivery

**Typical uses:** mail, packages, groceries, pharmacies, takeout food and beverages, and more

With more deliveries, less room for traffic and parking, and a huge push for cleaner air, you need to think out of the (gear)box.

- Meet strict emissions standards and avoid congestion taxes
- Navigate narrow city streets with ease and park anywhere without blocking traffic
- Deliver products and services quickly and quietly
- Differentiate your business with a visible commitment to sustainability

*Best choice: City or Urban models*



Ideal for  
Public sector  
Facility management  
Leisure & outdoor

# Garia Utility Park

*Handle virtually any task in pedestrian areas, car-free zones and campus environments*

Just because you're off road doesn't mean you have to sacrifice the feel of a quality driving experience.

This entry-level, CE-compliant vehicle is ideal for parks, resorts, industrial estates, warehouses or wherever you need to transport people and goods without driving on public roads. It is not road legal.

Since the drivetrain is electric, you can use the Garia Utility Park indoors and outdoors without disturbing anyone.

Modify the vehicle's standard specifications to match your requirements. From length and

configuration of the cargo bed to what you add to the market's most spacious cab, you create your vehicle.

#### Handle any landscape

Turf and all-terrain tires are just two of your many options for customization. With the vehicle's high-torque motor, both off-road tire types are ideal for challenging landscapes.

Want the ultimate driver comfort? Combine any tire with power steering.

Download the product sheet at [gariautility.com](http://gariautility.com)



TOP SPEED  
30 KM/H



BED LOAD  
UP TO 800 KG



USE INDOORS &  
OUTDOORS



TURNING RADIUS  
FROM 3.9 M



FITS NARROW  
SPACES

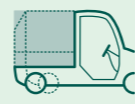

CUSTOM  
CONFIGURATIONS



TOP SPEED  
45 KM/H



ROAD  
LEGAL



RANGE UP TO  
200 KM



BED LOAD  
UP TO 800 KG



FITS NARROW  
SPACES

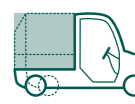

CUSTOM  
CONFIGURATIONS

Ideal for  
Public sector  
Facility management  
Leisure & outdoor  
Last-mile

# Garia Utility City

*Use on busy and narrow streets any time of day or night (class L7e)*



Ahhh, this is what a good workday feels like. The Garia Utility City thrives on navigating busy streets and narrow lanes. Small, agile and quick to accelerate, it flows seamlessly through the city.

Park without blocking traffic. Step in and out easily, safely and ergonomically, thanks to rear-hinged doors and a transparent cab. And a whisper-quiet drivetrain means you never disturb grouchy Mr. Jensen or his yappy dogs.

#### The road-legal bestseller

EU type-approved, the Garia Utility City can be registered for road use in all EU countries. Standard equipment includes 3-point seatbelts, adjustable side mirrors and E-marked headlights and tail lights. Configure the vehicle to meet your exact needs, including a wide range of options, accessories and batteries.

Download the product sheet at [gariautility.com](http://gariautility.com)



Ideal for  
Public sector  
Facility management  
Last-mile

# Garia Utility Urban

*Get wherever you want to go fast  
(class N1 – financial incentives possible)*

There's nothing stopping you now – except work, of course! With a top speed of 55 km/h, superior handling and quick acceleration, the Garia Utility Urban keeps up with traffic. At 1365 mm wide, it also parks easily on busy streets, making it ideal for inner city and last-mile applications.

### Safe, efficient and smart

Glide in and out of the spacious, transparent cab's rear-hinged doors. No matter the time of day, you won't disturb a soul. They won't disturb you either, thanks to enhanced safety features such as automatically locking doors and an AVAS alert system.

The Garia Utility Urban is EU road legal and crash tested according to European standards. Tailor it exactly as you want to meet your standards, too.

### Do you qualify for public support?

In many European countries, N1 class electric vehicles such as this benefit from financial subsidies. Your local dealer can tell you about your opportunities to save and avoid congestion charges.

[Download the product sheet at \[gariautility.com\]\(http://gariautility.com\)](#)



TOP SPEED  
55 KM/H



ROAD  
LEGAL



RANGE UP TO  
200 KM



CASH-BACK FINANCIAL  
INCENTIVES



CRASH-TESTED  
AND SAFE



BED LOAD  
UP TO 800 KG

See how they  
compare *before*  
*customization*

### STANDARD PARK MODEL

Road approval	Local	Headlights	Standard
Speed up to	30 km/h / 19 mph	On-board charger	Standard
Range up to	200 km*	Hydraulic brakes	Standard
Bed load capacity	Up to 800 kg	Automatic parking break	Standard
48 volt	6 x 8 volt	Bench seat	Standard
Standard battery	T875 (lead acid)	Reverse buzzer	Standard
Turning radius from	3.9 meters		

### STANDARD CITY MODEL

Road approval	L7e	Hydraulic brakes	Standard
Speed up to	45 km/h / 28 mph	Automatic parking break	Standard
Range up to	200 km*	Bench seat	Standard
Bed load capacity	Up to 800 kg	Heated windscreen	Standard
48 volt	8 x 6 volt	Wipers & washer	Standard
Standard battery	T145 (lead acid)	Speedometer	Standard
Turning radius from	3.9 meters	Side mirrors	Standard
Full light pack	Standard	Seatbelts	Standard
On-board charger	Standard		

### STANDARD URBAN MODEL

Road approval	N1	2 individual seats, adjustable	Standard
Speed up to	55 km/h / 34 mph	Heated windscreen	Standard
Range up to	200 km*	Wipers & washer	Standard
Bed load capacity	Up to 800 kg	Speedometer	Standard
48 volt	200 Ah	Side mirrors	Standard
Standard battery	Lithium 200 Ah	Rear fog lights	Standard
Turning radius from	3.9 meters	Doors	Standard
Full light pack	Standard	Seatbelts	Standard
On-board charger	Standard	Door sensors & electronic locks	Standard
Hydraulic brakes	Standard	AVAS system	Standard
Automatic parking break	Standard		

\* Extreme duty only available upon special request.



# A taste of what you have to look forward to



**Room to perform your best**  
The market's most spacious, comfortable cab features unrivalled head and leg room, excellent visibility, and no wheel arches to block easy, speedy entry/exit. Everything is within reach of both the operator and passenger for maximum efficiency.

**Protects your valuables**  
The lockable front trunk provides secure storage space. It also gives easy access to the fuse box and other technical components.

**Feels like a high-end car**

Stretch out your legs and enjoy the high-end, soft-touch feel of the pedals. The cab minimizes outside noise. Low vibration and superior suspension ensure a smooth ride.



**Supports safe operation**

Easily adjust the side mirrors from inside. The fully transparent cab also gives excellent visibility to help protect pedestrians, cyclists and property.



**Spacious, handy storage**

Need a cold one on a hot day? Choose the optional refrigerator. Or enjoy the spacious in-dash storage space instead, which is standard for every vehicle.



**Easy, efficient entry/exit**

Rear-hinged doors open wide and make it easy to get in and out of the vehicle.



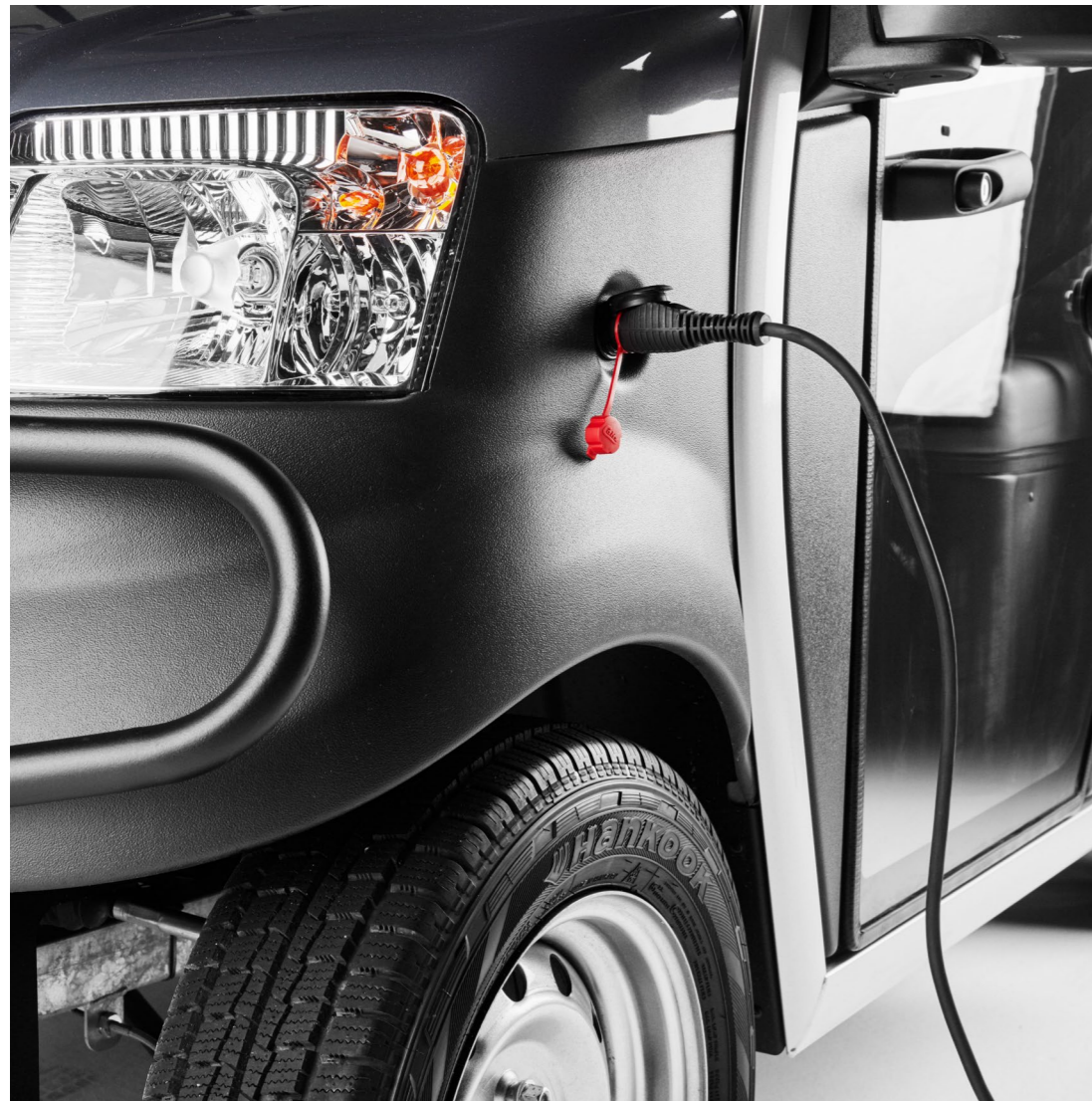

**Convenient charging**

The onboard Delta-Q charger lets you charge anywhere using a standard wall socket. Charging time varies according to battery type.



**Fits everywhere you need to go**

At only 1365 mm wide, every model fits on narrow streets and curvy paths and easily navigates obstacles. It's easy to find parking, and you never block traffic.

**Ergonomic and efficient**

All vehicle controls and accessories are ergonomic and logically located. The automotive-style dashboard is easy to clean.



**Built to last**

The heat-treated galvanized steel frame forms a rigid, stable structure for safety and unmatched corrosion resistance. Our vehicles have passed European crash test standards.

**Safety first**

As soon as the vehicle starts moving, the doors lock automatically.



# Choose the ideal battery for your application

Both lithium and lead acid options are available. Typically, lithium battery technology is superior. But lead acid batteries are less expensive and can be better for infrequent use.

Both types emit no pollution. Just let your dealer know if you need guidance.

**Lead acid: cost-efficient for infrequent use**

Lead acid batteries are made with lead and contain sulfuric acid. If you're only going to be using your vehicle infrequently or for short distances, this might be your best choice.

Choose from two lead acid deep-cycle battery configurations: standard and heavy duty

(for increased performance and range). Both have only one water refill point for speed and convenience.

**Lithium: long life and high load capacity**

Lithium batteries are lighter than lead acid – enabling higher load capacity – but cost more upfront.

Choose from five sizes of lithium batteries. Fewer replacements, higher efficiency and lower weight/higher load capacity can contribute to a lower total cost of ownership. Every lithium battery comes with a 3-year capacity warranty. The largest lithium battery pack enables a range of at least 200 km per day.

[Get information on battery storage at gariautility.com](http://gariautility.com)



Lithium



Lead acid

LEAD ACID OR LITHIUM?	LEAD ACID	LITHIUM
Low upfront cost	x	
Best for infrequent use	x	
Uses full battery capacity		x
High efficiency		x
Long lifespan		x
Extended warranty		x
High load capacity		x
Low weight		x

LEAD ACID	RANGE	WEIGHT	CHARGE TIME
6 x 8V T875 - standard duty WLTP*	40 km / 24 miles	177 kg	6-8 hours
8 x 6V T145 - heavy duty WLTP	60 km / 37 miles	274 kg	8 hours

\* Standard duty T875 batteries are not available on City or Urban models.

LITHIUM	RANGE	WEIGHT	CHARGE TIME	KWH TO RECHARGE
120 Ah / 6.1 kWh	55 km / 34 miles	62 kg	6 hours	6.1 kWh
180 Ah / 9.2 kWh WLTP	75 km / 46 miles	94 kg	6-7 hours	9.2 kWh
200 Ah / 10.2 kWh WLTP	85 km / 52 miles	131 kg	6-8 hours	10.2 kWh
240 Ah / 12.2 kWh WLTP	100 km / 62 miles	125 kg	7-9 hours	12.2 kWh
420 Ah / 21.4 kWh*	200 km / 125 miles	244 kg	10+ hours	21.4 kWh

\* Extreme duty only available upon special request.



## Configure your vehicle

Choose from more than 100 different configurations, options and accessories to

create exactly the vehicle that meets your needs. All models are available as a 2-seat

cab with a short or extended chassis.

DIMENSIONS	SHORT CHASSIS	EXTENDED CHASSIS
Width without side mirrors	1365 mm	1365 mm
Width with side mirrors	1731 mm	1731 mm
Length	3225 mm	3584 mm
Height	1865 mm	1865 mm
Bare chassis height	633 mm	633 mm
Ground clearance	230 mm	230 mm
Wheel base	2117 mm	2731 mm
Turning radius	3.9 m	4.6 m

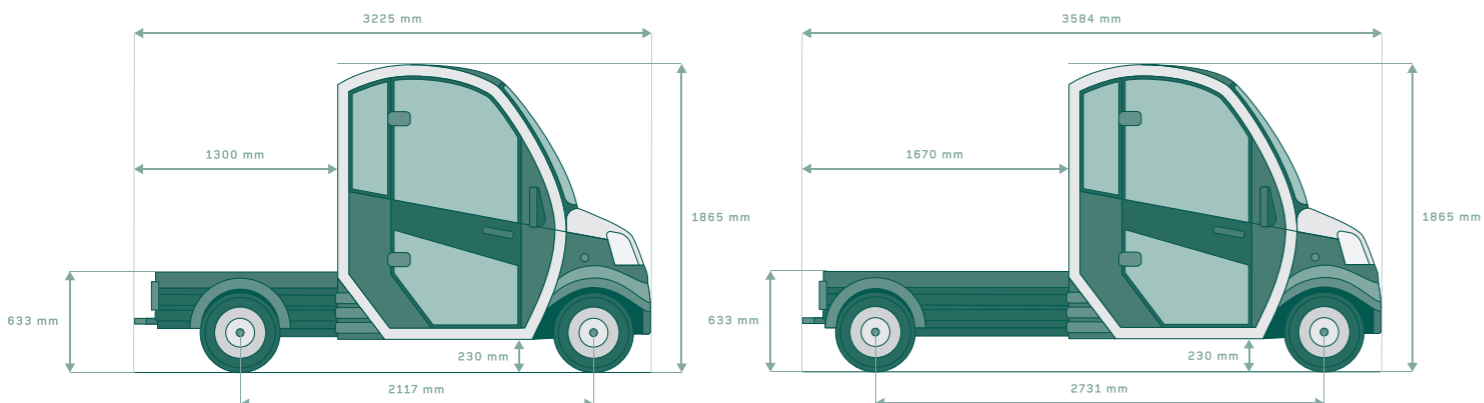

### REAR VEHICLE CONFIGURATION

REAR VEHICLE CONFIGURATION	SHORT CHASSIS	EXTENDED CHASSIS
Chassis only	Standard	Standard
Cargo bed short L. 1258 x W. 1215 x H. 300 mm	Option	-
Cargo bed long L. 1618 x W. 1215 x H. 300 mm ***	Option	Option
Cargo bed extended L. 2120 x W. 1215 x H. 300 mm	-	Option
Electric tilt bed	Option	Option
Mesh cage for short bed L. 1258 x W. 1215 x H. 1038 mm	Option	-
Mesh cage for long bed L. 1618 x W. 1215 x H. 1038 mm	Option	Option
Mesh cage for extended bed L. 2120 x W. 1215 x H. 1038 mm	-	Option
Rear window mesh protection	Option	Option
1.4 m <sup>3</sup> closed vanbox L. 1194 x W. 1236 x H. 1095 mm*	Option	-
2.1 m <sup>3</sup> closed vanbox L. 1594 x W. 1244 x H. 1095 mm**	Option	Option
2.8 m <sup>3</sup> closed vanbox L. 2109 x W. 1244 x H. 1095 mm**	-	Option
4.1 m <sup>3</sup> closed vanbox L. 2109 x W. 1244 x H. 1600 mm**	-	Option
4.5 m <sup>3</sup> closed vanbox L. 2109 x W. 1244 x H. 1600 mm** Plus diffuser above cabin	-	Option

\* With rear doors. \*\* With rear doors (side doors optional). \*\*\* 1618 mm bed is not an option on short Urban model.

## Rear vehicle configurations

### Short chassis

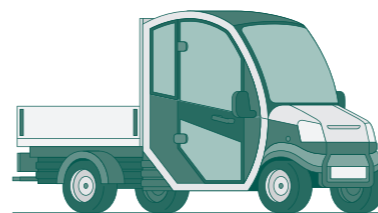

Short cargo bed with removable drop sides

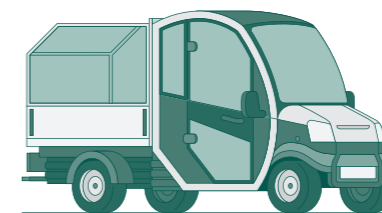

Mesh cage for short bed

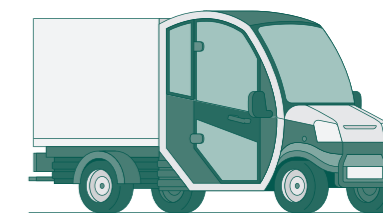

1.4 m<sup>3</sup> closed vanbox

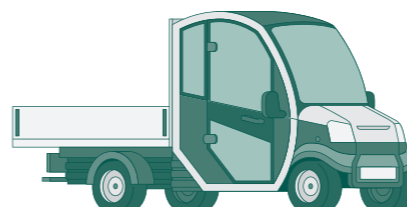

Long cargo bed with removable drop sides\*

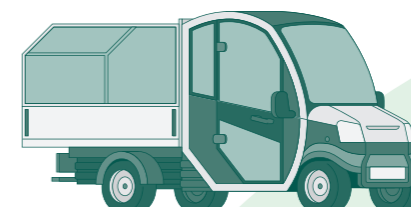

Mesh cage for long bed

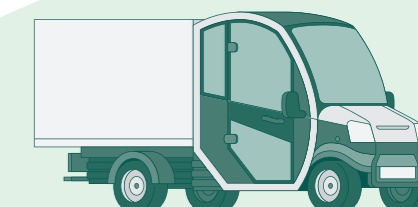

2.1 m<sup>3</sup> closed vanbox

## Rear vehicle configurations

### Extended chassis

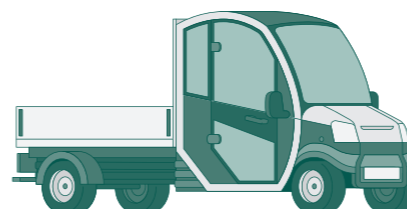

Long cargo bed with removable drop sides

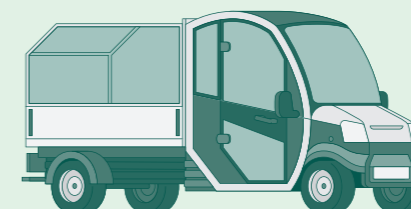

Mesh cage for long bed

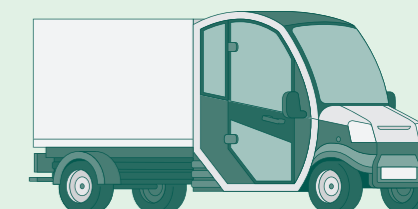

2.1 m<sup>3</sup> or 2.8 m<sup>3</sup> closed vanbox

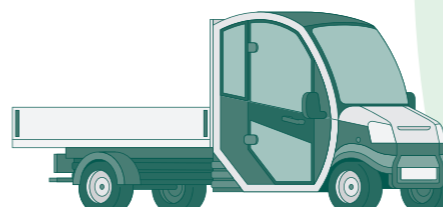

Extended cargo bed with removable drop sides

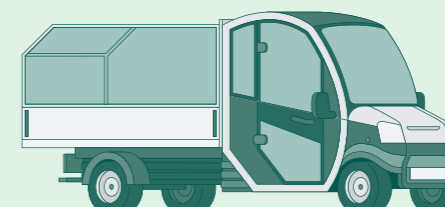

Mesh cage for extended bed

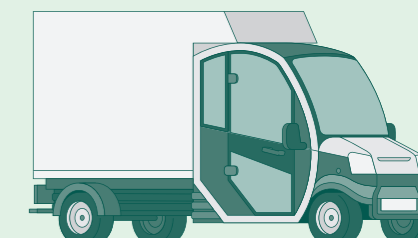

4.1 m<sup>3</sup> or 4.5 m<sup>3</sup> closed vanbox

\* Not available on short Urban model.



## Choose the accessories that work for you

<b>COLORS</b>	PARK MODEL	CITY MODEL	URBAN MODEL
White	Standard	Standard	Standard
Blue	Option	Option	Option
Gray	Option	Option	Option
Orange	Option	Option	Option
Custom color	Option	Option	Option
Custom decal	Option	Option	Option

### GENERAL EQUIPMENT

3-point seat belts	-	Standard	Standard
Base cluster (battery indicator)	Standard	-	-
Premium cluster (speedometer & battery indicator)	Option	Standard	Standard
Rear warning reflector triangle	Option	-	-
Horn	Option	Standard	Standard
Mirror package (adjustable side mirrors)	Option	Standard	Standard
Front windshield wiper/washer	Option	Standard	Standard
Rear light package (turn signals & reverse light)	Option	Standard	Standard
Heated windscreen	Option	Standard	Standard

### BATTERIES

6 x 8V battery pack T875	Standard	-	-
8 x 6V HD battery pack T145	Option	Standard	-
Lithium 120 Ah / 6.1 kWh	Option	-	-
Lithium 180 Ah / 9.2 kWh	Option	Option	-
Lithium 200 Ah / 10.2 kWh	-	-	Standard
Lithium 240 Ah / 12.2 kWh	Option	Option	-
Lithium 420 Ah / 21.4 kWh*	Option	Option	-
Single-point water filling system (lead acid only)	Standard	Standard	-

### TRACTION MOTORS

3 kW	Standard	Standard	-
8 kW (only with upgraded batteries)	Option	Option	Standard

\* Extreme duty only available upon special request.

<b>COMFORT EQUIPMENT</b>	PARK MODEL	CITY MODEL	URBAN MODEL
Lockable cab door, rear hinged	Option	Option	Standard
Split doors (right side only)	Option	Option	-
Cabin heater with thermostat (electric or diesel)	Option	Option	Option
Refrigerator (built into the dashboard)	Option	Option	Option
Cabin upgrade (sun visor, 12V outlet, interior light)	Option	Option	Standard
Radio with USB (only available with cabin upgrade)	Option	Option	Option
Leather steering wheel	Option	Option	-
Power steering*	Option	Option	Option
2 Individual seats, adjustable	Option	Option	Standard
Bench seat	Standard	Standard	-
Automatic parking brake	Standard	Standard	Standard
Steering column mounted direction selector	Standard	Standard	Standard
Built-in charger	Standard	Standard	Standard
Headlights	Standard	Standard	Standard
Cup holder	Standard	Standard	Standard
Storage compartments in dashboard	Standard	Standard	Standard
Speed handles and jacket hooks	Standard	Standard	Standard

### ADDITIONAL EQUIPMENT

Tow hook with trailer lights coupling	Option	Option	Option
Speed switch	Option	Option	Option
Reverse camera	Option	Option	Option
Right-hand drive	Option	Option	Option
Roof-mounted beacons / flashing light	Option	Option	Option
Reverse buzzer	Standard	Option	Option
L7e homologated	-	Standard	-
N1 homologated	-	-	Standard
All-terrain tires*	Option	Option	Option

### BODY PROTECTION / FLAME PROTECTION

Brush guard	Option	Option	-
Side protection nerf bars	Option	Option	Option
ATEX Zone 1&2 available	Option	Option	Option

\*Not homologated



## Overall specifications

PERFORMANCE	PARK MODEL	CITY MODEL	URBAN MODEL
Standard-duty motor continuous power (S2=60min.)	3 kW (4Hp)	3 kW (4Hp)	-
Peak power	11 kW (15Hp)	11 kW (15Hp)	-
Heavy-duty motor continuous power (S2=60min.)	8 kW (11Hp)	8 kW (11Hp)	8 kW (11Hp)
Peak power heavy-duty motor	15 kW (20Hp)	15 kW (20Hp)	15 kW (20Hp)
Motor controller	Curtis 350 A	Curtis 350 A	Curtis 350 A
Batteries	Trojan T875 6x8V	Trojan T145 8x6V	Lithium 200 Ah
Battery capacity, 5h rate (lead acid)	145 Ah	215 Ah	-
Chassis: steel frame	Galvanized	Galvanized	Galvanized
Brakes, hydraulic: front / rear	Discs / Drums	Discs / Drums	Discs / Drums
Tires	165 / 70 R13 C 88	165 / 70 R13 C 88	165 / 70 R13 C 88
Top speed	30 km/h / 19 mph	45 km/h / 28 mph	55 km/h / 34 mph
Range WLTP 6 x 8V battery pack T875	40 km / 24 miles	-	-
Range WLTP 8 x 6V HD battery pack T145	60 km / 37 miles	60 km / 37 miles	-
Range lithium 120 Ah / 6.1 kWh	55 km / 34 miles	-	-
Range WLTP lithium 180 Ah / 9.2 kWh	75 km / 47 miles	75 km / 47 miles	-
Range WLTP lithium 200 Ah / 10.2 kWh	85 km / 52 miles	85 km / 52 miles	85 km / 52 miles
Range WLTP lithium 240 Ah / 12.2 kWh	100 km / 62 miles	100 km / 62 miles	-
Range lithium 420 Ah / 21.4 kWh*	200 km / 125 miles	200 km / 125 miles	-
Towing capacity (braked trailer)	500	-	-
Towing capacity (unbraked trailer)	300	-	-
Climb angle	25%	25%	25%

### WARRANTY

Manufacturers limited warranty: years / hours	3 / 3,000	3 / 3,000	3 / 3,000
---	-----------	-----------	-----------



## Load data for all models

LOAD	SHORT CHASSIS	EXTENDED CHASSIS
Front axle max load	730 kg	730 kg
Rear axle max load	945 kg	1120 kg
Bed load	400 kg	800 kg
Technically permissible maximum mass	1350 kg	1850 kg

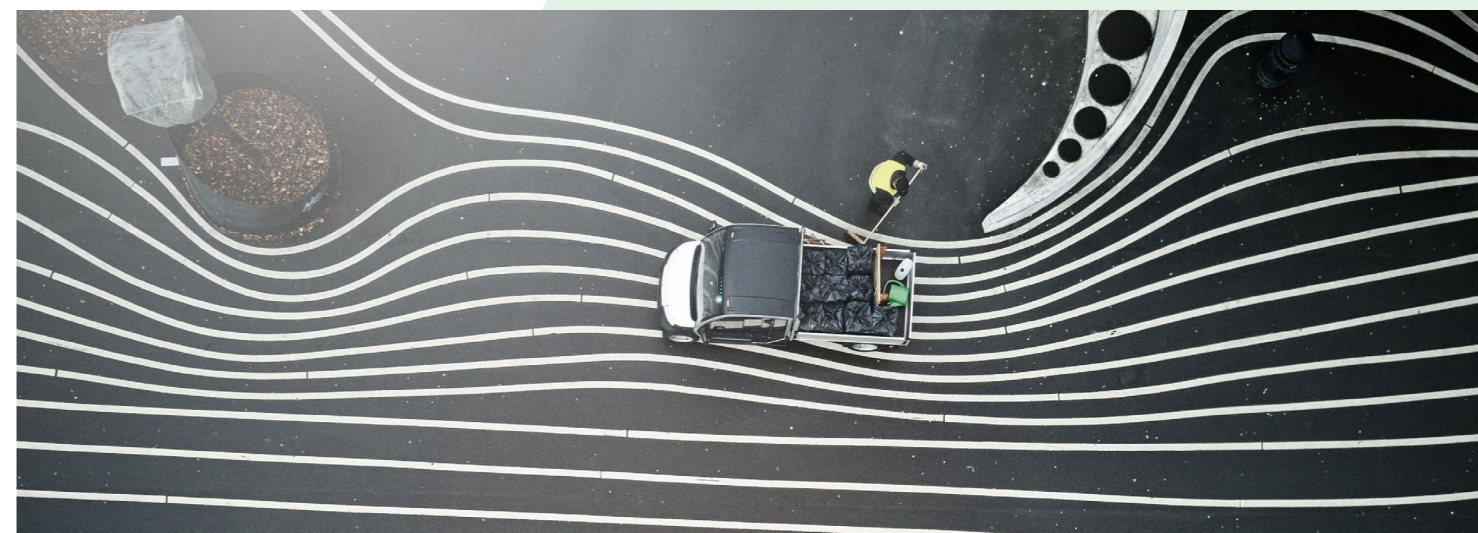

\* Extreme duty only available upon special request.



# Pleasure works

Dealer label

## CONTACT:

+45 46 570 580

[sales@gariautility.com](mailto:sales@gariautility.com)

[GARIAUTILITY.COM](http://GARIAUTILITY.COM)

f in  



Printed matter  
5041 0740



@Garia A/S 2021. All rights reserved.  
No part of this brochure may be reproduced without written permission from Garia A/S. All information correct at time of publication. Garia reserves the right to alter specifications and other product information at any time without prior notice.

Part no. U21 987 021 02 ENG